

# EcoDiesel Installation Manual

## CNG Applications

Rev. 1.8

## TABLE OF CONTENTS

<b>3</b>	<b>– Required tools and materials</b>
<b>3</b>	<b>– Technical Service Contacts</b>
<b>4</b>	<b>– Work Safety Statement</b>
<b>4</b>	<b>– Pre-installation Vehicle Evaluation</b>
<b>5</b>	<b>– Component Checklist</b>
<b>6</b>	<b>– Component Description</b>
<b>14</b>	<b>– Installation Procedure</b>
<b>24</b>	<b>– Wiring Schematic</b>
<b>25</b>	<b>– Appendix A – Wiring Techniques</b>
<b>28</b>	<b>– Appendix B – Air Compressor Charge Air Inlet Line Re-location</b>
<b>29</b>	<b>– Appendix C – Automatic Transmission Torque Monitoring</b>
<b>30</b>	<b>– Appendix D – Controller Mounting Template</b>
<b>31</b>	<b>– Appendix E – Installation on 24 or 36 volt electrical systems</b>

# EcoDiesel System™

## INSTALLATION GUIDE

**Installer – Please take adequate time to read this manual completely before attempting installation. The information contained herein will ensure a proper and simplified installation of the EcoDiesel System™. Deviation from procedures outlined in this manual may cause equipment damage and void warranty.**

### Installation Tools & Equipment

**Aside from basic hand tools, below is a list of other tools that will be required for installation.**

- Digital Volt Ohm Multi-Meter
- Soldering Iron or Gun
- Drill
- 1/8" NPT pipe tap
- Electrical terminal crimp tool/wire stripper
- A laptop computer with USB port, Windows XP
- USB-A to USB-B cable\* to connect the laptop computer to the EcoDiesel System Controller
- Oetiker Clamp Crimping Tool\* (a pair of "end cutting pliers" may be used)

(\* ) Available from Technocarb Equipment (2004) Ltd.

**Additional items required that are NOT INCLUDED with the system kit.**

- Alternative fuel storage tanks/cylinders, coalescing filter, fuel lines, fittings, remote refueling valve

#### TECHNICAL ASSISTANCE:

Technical support is available from 8am through 4pm (PST) Monday through Friday.

Ph#604-854-6264 or email: [ecodiesel@technocarb.com](mailto:ecodiesel@technocarb.com)

Technocarb Equipment (2004) Ltd: #4 30435 Progressive Way, Abbotsford, British Columbia, Canada, Postal Code V2T 6W3 Web: [www.technocarb.com](http://www.technocarb.com) Email: [sales@technocarb.com](mailto:sales@technocarb.com).

## SAFETY FIRST

**Note:** The descriptions and specifications outlined in this manual were in effect at the time this manual was approved for publication. Technocarb Equipment (2004) Ltd. reserves the right to discontinue models at any time, or change specifications or design without notice and without incurring obligation.

### SAFETY:

Appropriate service and repair methods are essential for the safe, reliable operation of all motor vehicles as well as the personal safety of the individual doing the installation, maintenance and repairs. Accordingly, anyone who departs from the instructions provided in this manual must first establish that they compromise neither their personal safety nor the vehicle integrity by their choice of methods, tools and parts.

- ALWAYS WEAR SAFETY GLASSES FOR EYE PROTECTION
- KEEP SOLVENTS AWAY FROM IGNITION SOURCES
- USE SAFETY STANDS WHENEVER UNDER THE VEHICLE SERVICES ARE REQUIRED
- OPERATE THE ENGINE ONLY IN WELL VENTED AREAS TO AVOID THE DANGER OF CARBON MONOXIDE POISONING
- KEEP YOURSELF AND YOUR CLOTHING AWAY FROM MOVING PARTS
- AVOID CONTACT WITH HOT METAL PARTS SUCH AS THE RADIATOR, EXHAUST SYSTEM, CNG REDUCER  
DO NOT SMOKE WHILE WORKING AROUND THE VEHICLE
- AVOID INJURY, REMOVE RINGS, WATCHES, LOOSE HANGING JEWELRY, AND LOOSE CLOTHING
- DO NOT TIGHTEN LOOSE GAS FITTINGS WHENEVER THE CNG SYSTEM IS OPEN AND UNDER PRESSURE
- DO NOT VENT CNG INTO AN ENCLOSED BUILDING
- ADHERE TO EACH AND EVERY CODE SPECIFIC TO YOUR CITY, PROVINCE, STATE OR JURISDICTION CONCERNING THE FITTING OR SERVICE OF CNG ALTERNATIVE VEHICLE FUEL SYSTEMS

### Pre-Installation Vehicle Evaluation

Prior to the installation of the **EcoDiesel System™**, the vehicle should be first evaluated for its performance on diesel. Any and all concerns related to the vehicle operation on diesel must be corrected prior to the installation of the **EcoDiesel System™**.

## Component Checklist

Below are listed the contents of the *EcoDiesel System™* kit, please check over and familiarize yourself with all the parts prior to installation.

- 1 – *EcoDiesel System™* Controller
- 1 – Main wiring harness
- 1 – TPS sub harness
- 1 – RPM sub harness
- 1 – Pressure sensor
- 1 – Power switch/fuel gauge
- 1 – EGT sensor assembly
- 1 – RPM interface module
- 1 – CNG fuel level interface
- 1 – Fuse holder and fuse
- 10' – 3/8" wire loom
- 10' – 1/2" wire loom
- 1 – CNG regulator and lock-off assembly
- 6' – 1/2" CNG gas line
- 1 – Injection nozzle
- 1 – 1/8 NPT to 3/16" hose barb fitting
- 5' – 3/16" fuel line
- 6' – 3/8" heater hose
- 2 – Small Oetiker clamps
- 4 – Large Oetiker clamps
- 1 – Small parts kit (8 hose clamps, 2 water Y's, heat shrink tubing, solder)
- 1 – Vapor fuel filter
- 2 – Hose clamps (for the above filter)

## Hardware Description

This section is included to help identify and familiarize you with the components of the *EcoDiesel System™*.

**CNG Storage Tanks** Technocarb Equipment (2004) Ltd. is not a supplier of CNG tanks.

**CNG Gas Line** may be made up on site in accordance with local regulations and safety practices. If required, specific fittings are available from Technocarb. It is recommended that a coalescing filter be installed in the high pressure line between the tank and the regulator.

### *EcoDiesel* CNG Regulator



- The mounting position of the CNG regulator may be orientated in any direction, however take into account easy routing of the line and hoses.
- CNG regulators convert high pressure CNG vapor to low pressure natural gas vapor. This process causes a substantial cooling effect and therefore requires a continuous flow of engine coolant through their water passages.
- Some vehicle manufacturers use a restrictor in one of the two heater hoses in order to control flow of coolant in and out of the heater core. The restrictor may have to be removed whenever it is established that there is insufficient coolant flow through the CNG regulator. Our research has proven that there are no heater performance issues created from the removal of the restrictor and the routing of coolant flow through a CNG regulator.
- The total coolant system must be in proper working order and a glycol to water mix ratio between 50:50 and 60:40. A proper mix ratio promotes heat transfer and prevents corrosion of the internal components of the CNG regulator.
- A regulator temperature sensor is mounted in the body of the regulator. The *EcoDiesel System™* controller uses this sensor to evaluate the proper operating parameters of the regulator.

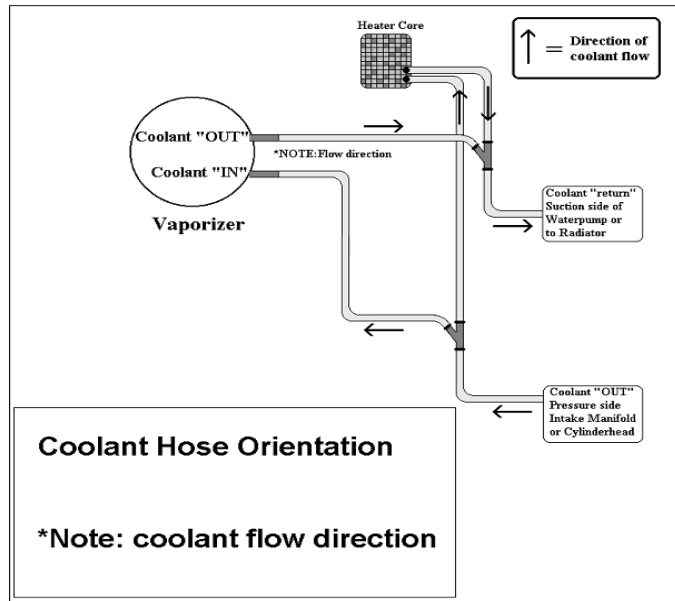

### EcoDiesel CNG Lock-off Solenoid



- The lock-off solenoid is mounted as part of the CNG regulator and interrupts the flow of CNG when the engine is shut down.
- Electrical power (12 volt battery voltage) and ground are controlled through the **EcoDiesel System™** controller.

## **EcoDiesel CNG Low Pressure Vapor Hose and Injection Nozzle**

- The vapor hoses are used to interconnect the CNG regulator, **EcoDiesel** controller, and the injection nozzle.
- Only use hose specifically designed for CNG vapor. The **EcoDiesel System™** kit includes a length of appropriate hose.
- A specially designed injection nozzle is provided for installation in the intake tubing. Specific details are provided in the installation part of this manual.



## **EcoDiesel Controller**

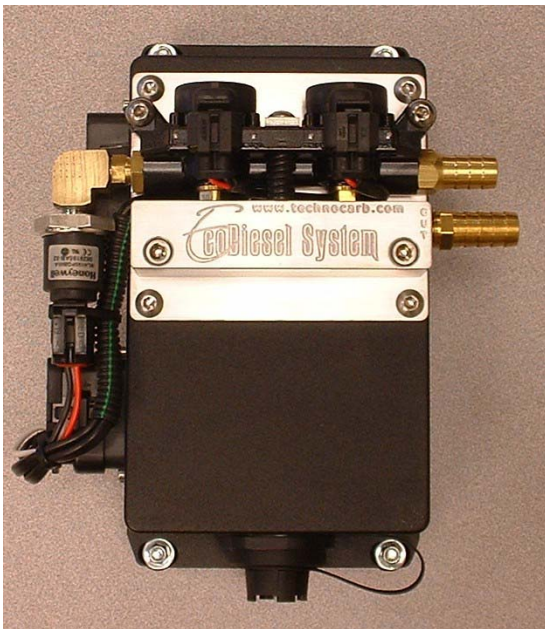

**USB Connection on bottom of unit**

- The **EcoDiesel System™** controller comes with vibration dampeners installed for mounting the unit. Some installations will require the fabrication of additional mounting brackets.
- A mounting hole template is available in appendix B of this manual.
- It is important to mount the **EcoDiesel System™** controller away from areas of high heat and excessive moisture. Never mount the controller anywhere on the engine.

## EcoDiesel CNG Wiring Harnesses

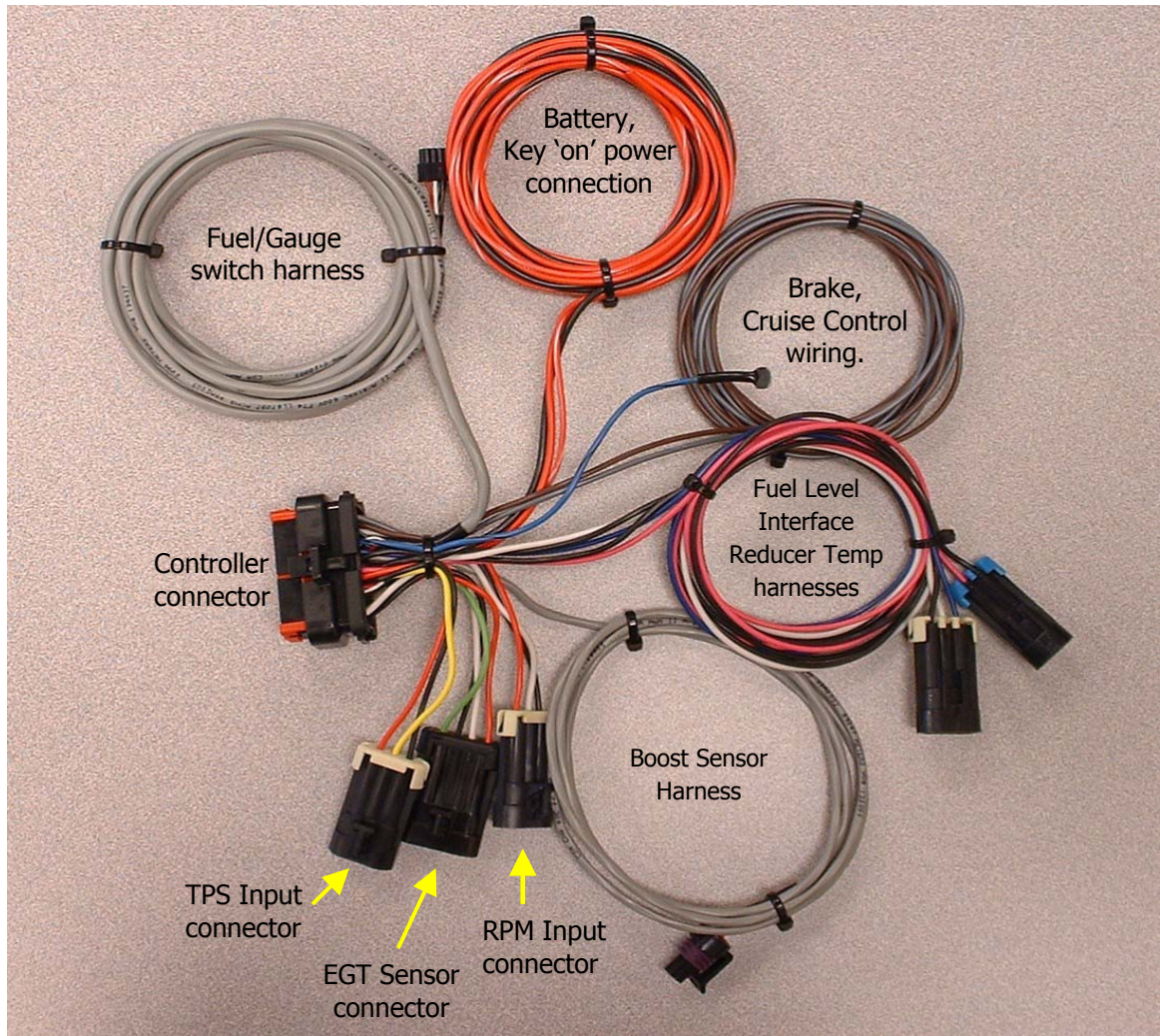

- The **EcoDiesel System™** controller has one main wiring harness that is further reduced into sub-harnesses for simplified installation.
- A length of split loom is provided to tidy wiring.
- Two pigtail harnesses are also provided for RPM and TPS connection, these are covered in detail in the wiring section of this manual



### **EcoDiesel Fuse Holder/Indicating fuse**



- A fuse holder and a 15A fuse are provided to install in the battery power wire. The fuse supplied is a Luma-Fuse™, that will illuminate if the fuse is blown helping locate a problem. Although the system will operate with a standard automotive blade fuse, replacement fuses of this type may be re-ordered from Technocarb.

### **EcoDiesel Power Switch/Fuel Gauge**



- This switch controls the on/off activation, and reports CNG fuel level.
- The top left hand corner has a yellow LED that will indicate the presence of stored diagnostic codes.
- The lower left hand corner of the switch has an auto diming sensor for more comfortable night use.
- Mount this switch in the vehicle dash or in a location accessible to the driver.
- The use of a step drill is recommended to provide a clean mounting hole.
- When installing the switch, only apply force to the outer edge of the switch avoiding direct pressure on the switch button.
- A direct plug in sub-harness is included as part of the main harness.

### **EcoDiesel EGT Sensor**

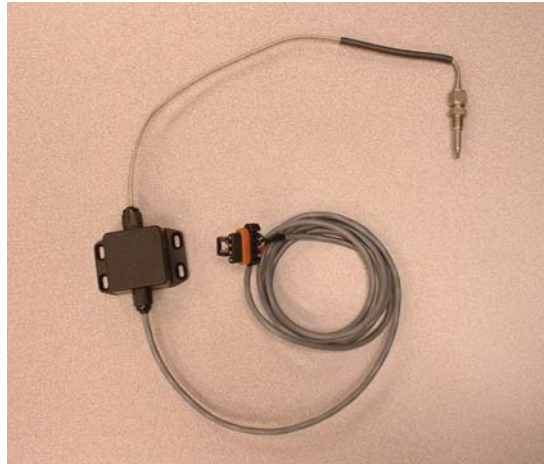

- The EGT sensor monitors exhaust gas temperature. The **EcoDiesel System™** controller utilizes the data to monitor for proper operation and also perform a safety shutdown.
- Mount the EGT sensor in the exhaust tubing exiting the turbo. For the most accurate results it must be located within 4 inches of the turbo housing outlet. The mounting hole must be drilled and tapped to 1/8" NPT.
- Install the fitting first then insert the sensor and snug the nut.
- The interface unit must be mounted away from the direct heat of the exhaust, however you may attach a bracket to the engine if required.
- The EGT sensor connector plugs directly into the main wiring harness. Any excess wire may be neatly coiled up and secured.

### **EcoDiesel RPM Signal Interface**

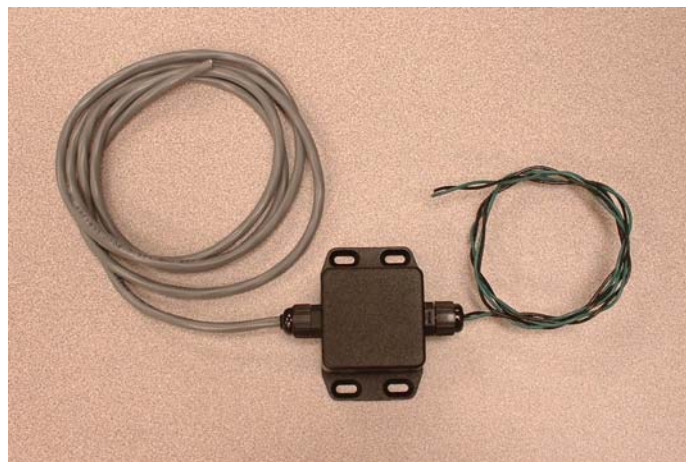

- The RPM signal interface adapts a reluctor style (2 wire) sensor to a clean square wave pulse for the **EcoDiesel System™** controller. The RPM signal is used as part of the gas injection mapping and therefore is required for the **EcoDiesel System™** to operate.
- The adapter may be mounted off the engine with a bracket if necessary, however wiring should be long enough to allow firewall (preferred) mounting.

### **EcoDiesel Boost Pressure Sensor**



- The pressure sensor measures the boost pressure from the turbo and uses this data as part of the gas injection pulse width calculation.
- This sensor mounts in the intake tubing near the gas injection nozzle, details are provided in the installation part of this manual.

### **EcoDiesel CNG Fuel Level Interface**



- This unit provides a fuel level signal for the Power/Fuel Gauge Switch and the **EcoDiesel** controller based on CNG tank pressure.

## **EcoDiesel** Boost Pressure Compensation



- The CNG regulator uses boost pressure to equalize its output pressure and deliver consistent gas pressure for stable operation.
- A 1/8 NPT brass nipple is supplied to mount in the intake tubing, details are provided in the installation part of this manual.
- A length of fuel line rated to handle the boost pressure is supplied. Only fuel grade hose should be used in this location as it is designed to handle pressure.

## **EcoDiesel** Vapor Fuel Filter



- A vapor fuel filter is supplied for installation between the LPG regulator and the **EcoDiesel System™** controller. This is a directional filter and must be installed with the arrow pointing toward the controller's gas inlet.
- This filter is a maintenance item with its service life determined by the cleanliness of the fuel supply. A common symptom of a clogged filter is low gas pressure and reduced performance.

## **EcoDiesel Installation Procedure**

The following steps are arranged in a recommended order for a simplified and proper installation. The CNG tank mounting location will be determined by available space on the particular vehicle. The CNG high pressure line routing will depend on both the tank and regulator locations. Routing this line should avoid close proximity to sources of high heat, moving parts, or sharp edges, and be installed according to local gas safety regulations. The installation of a coalescing filter is recommended in the high pressure line between the tank to the regulator.



### **Step 1 Post-Turbo Installations – Recommended Method**

Plan the location for gas injection nozzle, boost pressure sensor and regulator pressure compensation fitting into the intake tubing. A preferable location is between the turbo outlet and the intake manifold in a metal section of the tubing. If the engine also has an intercooler, it is recommended to install the components post intercooler if possible. If only a rubber hose exists, consider placing a metal piece of tubing in between. The injection nozzle will require a 5/8" dia. hole, while the boost pressure sensor and regulator pressure compensation fitting require 1/8 NPT threaded holes. An ideal location is 14" to 18" from the intake manifold.

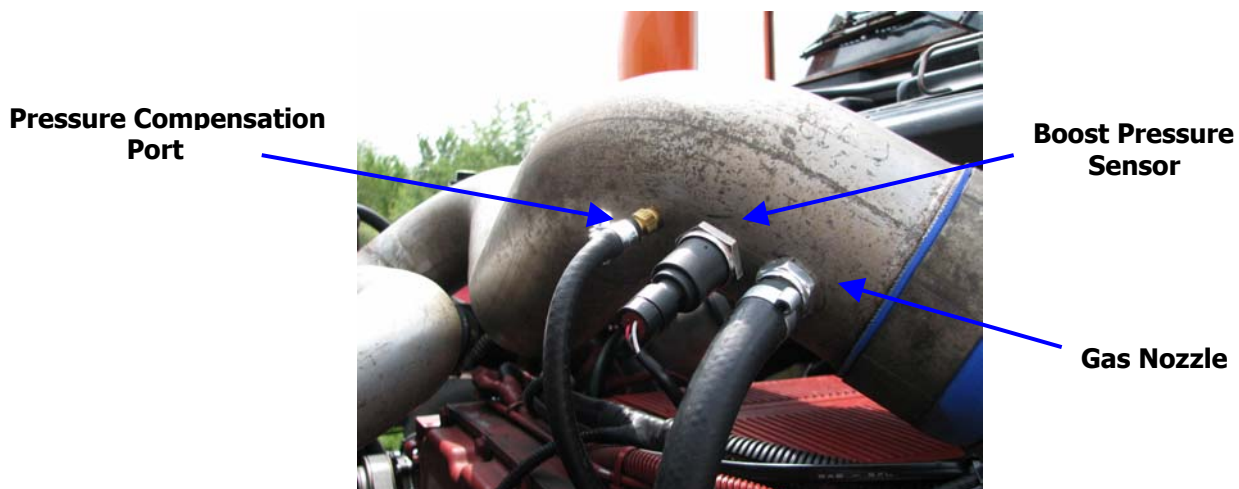

Mark out and drill the metal portion of the intake tube using the diagram below as a reference. The use of a step drill is recommended for the 5/8" gas nozzle hole, it will leave a clean undistorted hole which is necessary for proper sealing. \*\* The nozzle hole should be within 5" of the tube end so a wrench can be placed inside to aid in tightening the nozzle. Some discretion may be necessary, as not all intake tubing will measure up the same. The important keys are to have wrench access for tightening the injection nozzle and to ideally have it post intercooler (if possible) 14"-18" from the intake manifold.

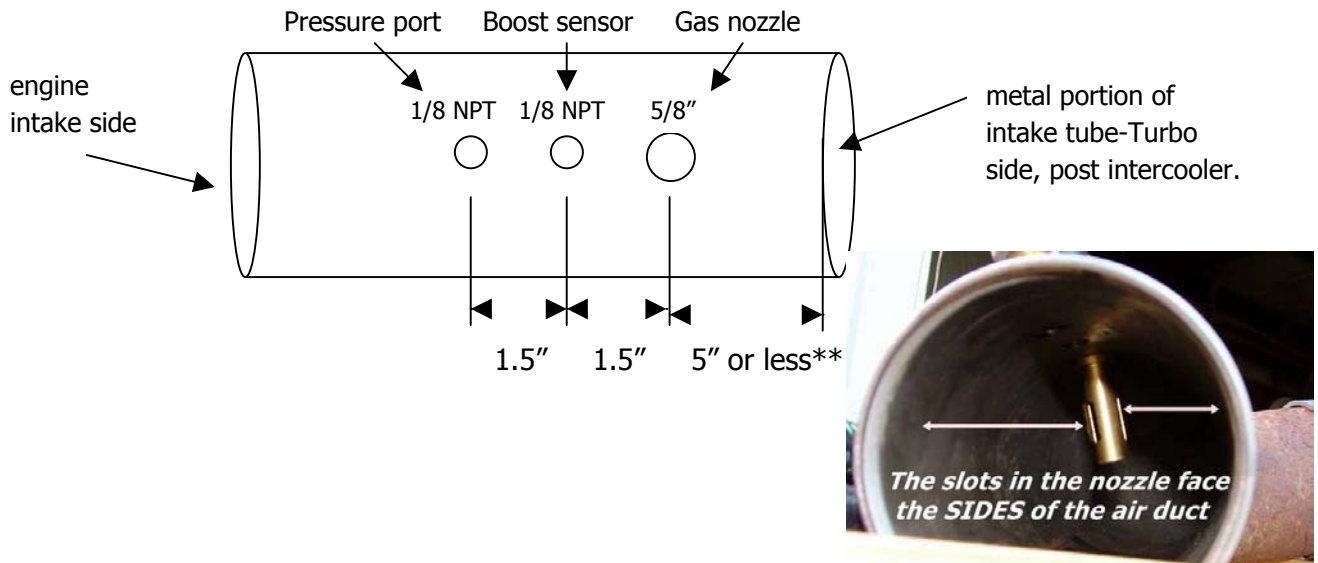

The boost pressure sensor and regulator pressure compensation fitting can be sealed with a small amount of lead based sealant such as Master's or Jet Lube #60. Only tighten the pressure sensor by the hex on the metal portion of the sensor using a 1 1/16" wrench or deep socket. Do not over-tighten to avoid damaging threads.

Insert the injector nozzle through the 5/8" hole from inside the tube with the barbed end exiting the hole on the outside of the tube. Use the supplied nylock to secure the nozzle. The nozzle has two flats milled on it's surface (part located inside the tube) to allow a 7/16" wrench to be used to hold it while tightening. Position the 7/16" wrench parallel to the tube wall so the nozzle is held in proper alignment during tightening (the two milled oval slots will face the inside tube walls). Proceed to step 2.

### STEP 1A Pre-Turbo or Non-Turbo Installations Only

For pre-turbo and non-turbo installations the gas injection nozzle and the regulator pressure compensation fitting will be mounted in the intake tubing prior to the turbo charger inlet. The boost pressure sensor will be required to be mounted in a post-turbo location. On non-turbo applications the boost pressure sensor will not used, however the balance of this step will apply.

Locate a metal section of intake tubing to mount the gas injection nozzle and regulator pressure compensation fitting. If necessary a short piece of metal tubing may be required to be inserted in a plastic or rubber intake hose. Alternately, if a plastic section of the intake tubing is suitable for drilling and tapping this may be used.

Mark out and drill the section of tubing using the diagram below as a reference. The use of a step drill is recommended for the 5/8" gas nozzle hole, it will leave a clean undistorted hole which is necessary for proper sealing. \*\* The nozzle hole should be within 5" of the tube end so a wrench can be placed inside to aid in tightening the nozzle. Some discretion may be necessary, as not all intake tubing will measure up the same. The important key is to have wrench access for tightening the injection nozzle.

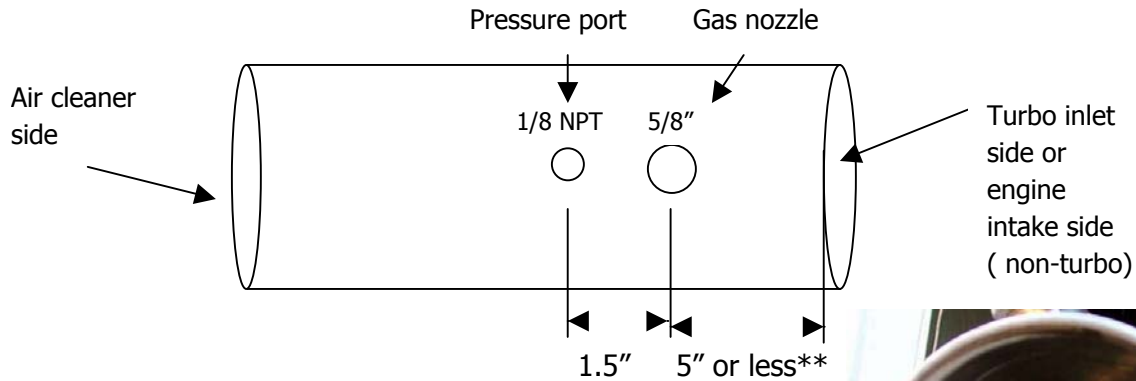

The pressure compensation fitting can be sealed with a small amount of lead based sealant such as Master's or Jet Lube #60. Do not over-tighten to avoid damaging threads. Insert the injector nozzle through the 5/8" hole from inside the tube with the barbed end exiting the hole on the outside of the tube. Use the supplied nylock to secure the nozzle. The nozzle has two flats milled on it's surface (part located inside the tube) to allow a 7/16" wrench to be used to hold it while tightening. Position the 7/16" wrench parallel to the tube wall so the nozzle is held in proper alignment during tightening (the two milled oval slots will face the inside tube walls).

The boost pressure sensor (except on non-turbo applications) will need to be mounted in a post-turbo section of tubing in a 1/8" NPT threaded hole. The boost pressure sensor can be sealed with a small amount of lead based sealant such as Master's or Jet Lube #60. Only tighten the pressure sensor by the hex on the metal portion of the sensor using a 1 1/16" wrench or deep socket. Do not over-tighten to avoid damaging threads. Proceed to step 2

## STEP 2 Controller and Regulator Installation

Select a mounting location for the controller and CNG regulator. It is recommended that these be located on the same side of the engine as the gas nozzle in order to keep the gas vapor lines as short as possible. Ideally a length of vapor hose between either the regulator and the controller or the controller to gas injection nozzle should not exceed 24 ". Although these lines can be longer, shorter lines will give better gas flow regulation. The regulator may be mounted in any position, however must in be a location at least 6" below the highest point of the radiator to avoid air lock conditions. The controller should be mounted vertically with the USB connector facing down. Either may be mounted directly to the firewall or with fabricated brackets. It is also recommended to use the supplied isolation mounts for both units. When choosing a mounting location for either of these two units, ensure there is ample room for hoses and connectors to be installed. Also mind locations near the outer areas of the firewall so they don't interfere with hood closure.

Below is a picture of an installation showing the recommended controller and regulator mounting. Proceed to step 3.

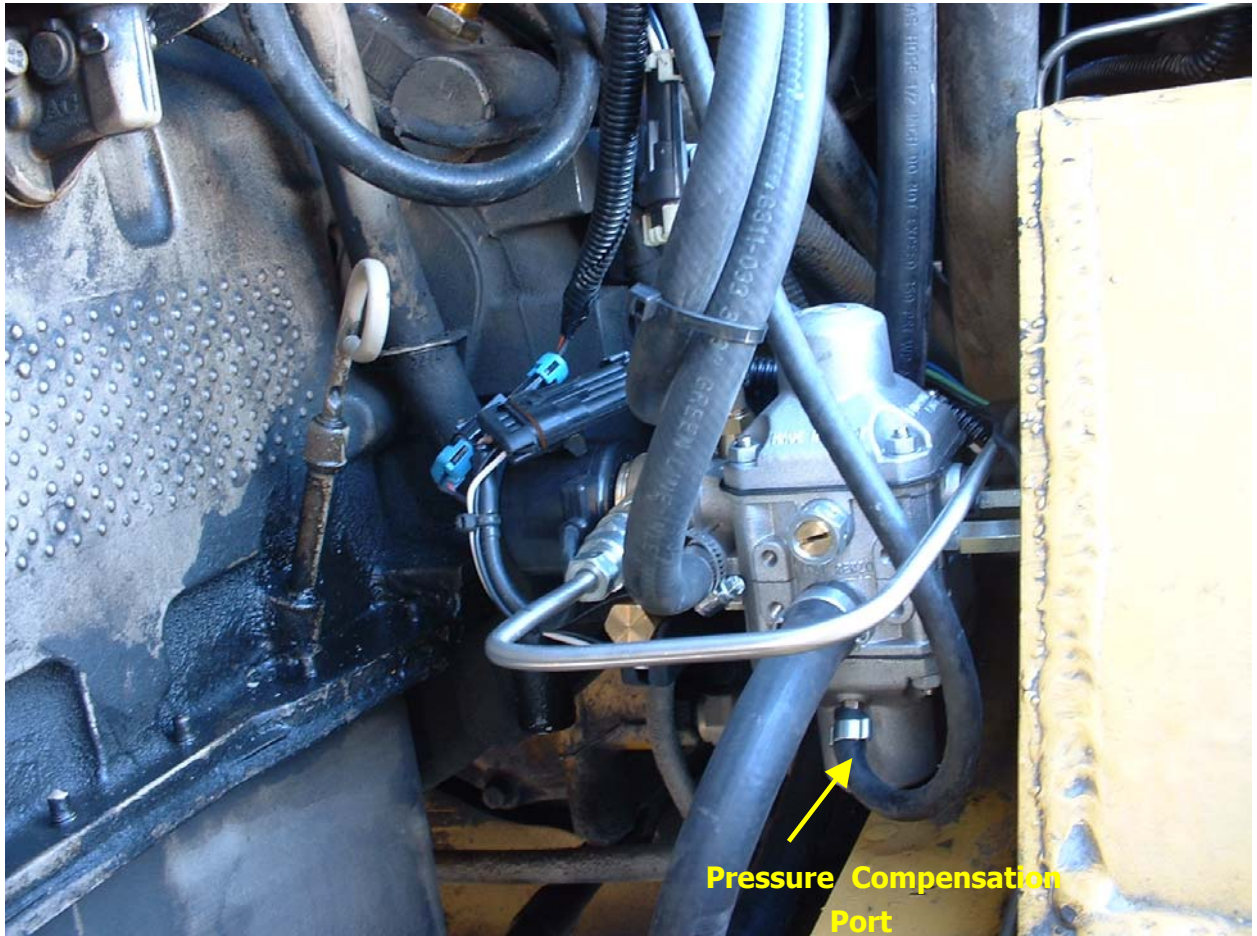

### STEP 3 Coolant Hoses

Inspect the heater hose configuration on the vehicle very carefully. For systems that use coolant flow control valves you will need to ensure that the water "Y"s are located on the engine side of the valve so flow through the water "Y" will not be affected when the flow control valve is closed. The water "Y"s have double size flow through nipples to accommodate either 5/8" or 3/4" hose and an outlet size of 3/8". The kit comes complete with a length of 3/8" heater hose to complete the installation. At this time also look for a restrictor orifice that is installed in the coolant output line (leaving engine) on some applications. Removal of this orifice is necessary, however will not affect heater operation. The CNG regulator's coolant nipples marked "water" but do not have a specific flow direction, so connection to either water "y" is acceptable. Use the supplied hose clamps to finish the installation. Proceed to step 4.

### STEP 4 Vapor Hoses

Using the 1/2" CNG vapor hose, connect the regulator to the controller inlet, and from the controller outlet to the gas injection nozzle. Allow sufficient length to avoid tight bends, and allow free engine movement. Use the supplied Oetiker clamps to secure the hose.

### STEP 5 Pressure Compensation Line

Using the 3/16" fuel line, connect the pressure compensation port on the regulator to the pressure compensation fitting mounted in the intake tubing. Secure the hose on both ends with the two small Oetiker clamps supplied.

### STEP 6 EGT Sensor

Next drill and tap a 1/8"NPT hole in the exhaust tubing to mount the EGT sensor. The preferred location is within 4" of the turbo housing. On a non-turbo application, install the sensor in the exhaust tubing directly after the exhaust manifold.



Remove the threaded fitting from the base of the EGT sensor and mount it in the exhaust tubing. Secure it with a wrench being careful not to over-tighten and damage the threads. Once the fitting is installed, the EGT sensor may be slid down inside and the upper mounting nut tightened. Mount the EGT interface unit on the engine firewall or a bracket off the engine. Allow a loop in the EGT wire to allow flex against engine movement.

## **STEP 7.0 Wiring**

Install the main wiring harness 35 pin connector into the controller. This is a weatherproof connector and will take a moderate force to seat. The connector is fully seated when the latch clicks into place. Route the various wires to their respective sensors, refer to the schematic for more detail. When routing any of the wires, avoid high heat or sharp areas. On cable with connectors attached, coil any excess wire and neatly mount it out of the way. Any wiring that are single un-terminated leads may be cut to length before connection.

### **Step 7.1 Boost Pressure Sensor Connection**

**3 conductor gray jacketed cable with round 3 pin connector - main harness**

Route the 3 pin round connector to the boost pressure sensor. Any excess wiring can be coiled up and tucked neatly away. Avoid very hot areas or sharp edges when routing the cable. Align the connector before exerting force to engage it. Do not attempt to shorten this cable.

### **Step 7.2 EGT Sensor Connection**

**4 pin connector with 18 ga. red/black/white/green - main harness**

Connect the 4pin EGT sensor connector to the 4pin pigtail on the controller main harness.

### **STEP 7.3 Power/Fuel Gauge Switch Connection**

**5 pin gray jacketed cable with 8 position black connector – main harness**

Route the gray jacketed wire with the 8 position black connector through the firewall for connection to the Power/Fuel level switch. As with any wiring passing through the firewall, choose either an existing grommet or install a new one, do not allow any wiring to go through an unprotected hole. Locate a position to mount the power/fuel level switch that will be convenient for the driver and drill a 13/16" hole preferably with a step drill. Route the wire through the hole and plug it into the switch, then mount the switch. Coil up any excess wiring under the dash out of the way of any moving controls (brake/clutch/throttle pedals, heater controls etc.). Do not attempt to shorten this cable, however should a longer cable be necessary a plug in extension cable is available from Technocarb.

### **STEP 7.4 TPS Connection (for vehicles equipped with a TPS sensor)**

**3 pin connector with 18 ga. red, black, yellow wires – main harness**

Locate the TPS sensor/wiring and separate the output wire. For applications that use multiple TPS sensors, it will be necessary to locate the output where the voltage increases with throttle position. A proper range would be 0.3 to 0.8 volts at idle and 3.0 to 4.5 volts at wide open throttle. Using the TPS pigtail (red/black/yellow wires), connect the yellow wire to the vehicle's TPS output wire. Strip back the insulation and perform a tap connection and then solder and tape it. Refer to appendix A for more detailed instructions on this type of connection if necessary.

Insulate both the red and black wires from the TPS pigtail as they are not required for this installation. Locate the 3 pin connector pigtail on the main harness that contains a red, black, and yellow wire. This connector will have a sealing plug installed. Remove the plug and plug in the TPS pigtail connector. The pigtail wiring may be lengthened or shortened if necessary. Proceed to Step 7.6

**STEP 7.5 TPS Connection (for vehicles not equipped with a TPS sensor)  
3 pin connector with 18 ga. red, black, yellow wires – main harness**

A TPS sensor is required for a number of fuel delivery functions, however it is mandatory for non-turbo applications. If the vehicle does not have a TPS sensor, one may be installed and the TPS pigtail may be used for the full connection. The Red wire is a +5v supply, black is ground, and yellow is the TPS output. For more information on such an application, please contact the Technical Department at Technocarb.

**STEP 7.6 RPM Signal for vehicles that use a 2 wire reluctor sensor  
3 pin connector with 18 ga. red, black, white wires – main harness**

Locate the RPM sensor, this may commonly be the crank sensor or a sensor located on the bell housing utilizing the ring gear for a signal. Note: If the vehicle has more than one source for RPM, choose the one that supplies the highest number of pulses per revolution. First mount the RPM interface module to the firewall or a bracket of the engine, route the 18 ga. green and black wires to the reluctor sensor and connect them in parallel with the existing vehicle wiring. The black wire is to be connected to the common ground side (if common mode ground exists). If unsure, connect the green and black wires up and see that the vehicle's tachometer continues to function properly. If the tachometer is affected, reverse the green and black wires. Route the gray harness with the 3 pin connector to the controller and plug it into the 3 pin pigtail located on the main harness that contains the red, black and white wires. The green and black wires may be shortened or lengthened if necessary. Proceed to step 7.9

**STEP 7.7 RPM Signal for vehicles that uses a 3 wire hall effect sensor  
3 pin connector with 18 ga. red, black, yellow wires – main harness**

Locate the RPM sensor, this may commonly be the crank sensor. Note: If the vehicle has more than one source for RPM, choose the one that supplies the highest number of pulses per revolution. On a three wire sensor there will be a ground, power source and output lead. Either consult a vehicle wiring diagram or use a digital voltmeter to locate the output wire by isolating the power and ground wires. DO NOT attempt to use a test light to test the sensor. Once the output lead is located, connect the 18 ga. white wire from the RPM pigtail harness to this lead. Strip back the insulation and perform a tap connection and then solder and tape it. Refer to appendix A for more detailed instructions on this type of connection if necessary.

Insulate both the red and black wires from the RPM pigtail as they are not required for this installation. Locate the 3 pin connector pigtail on the main harness that contains a red, black, and white wire. The pigtail wires may be lengthened or shortened if necessary. Plug the RPM pigtail into the remaining 3 pin connector on the main harness that will contain red, black and white wires. Proceed to step 7.9

**STEP 7.8 RPM Sensor Installation for vehicles that do not have a 2 or 3 wire sensor**

For rare applications that do not have a 2 or 3 wire RPM sensor, a standalone sensor may be installed. This sensor will mount in the bell housing and use the ring gear as a trigger source. This sensor may be purchased from Technocarb and more complete details received from the Technical Department. Call for details.

**STEP 7.9 Cruise Control Wiring for vehicle equipped with cruise control**  
**18 ga. Brown wire – main harness**

For vehicle's that have cruise control, the 18ga. brown wire from the main controller harness is to be connected to the cruise control trigger wire. If the vehicle does not have cruise control, simply cap off the brown wire and neatly tuck it away. On most cruise control systems there is a cruise main power switch and a set/resume switch. Locate the output wire from the "set" side of the switch. This wire will produce a ground signal when the switch is activated. To test for this wire, connect a voltmeter between this wire and ground. This wire should read between 5 and 12 volts normally, and when the button is pushed the voltmeter should read ground. Releasing the button should return the previous voltage reading. Once confirmed, strip back the insulation and perform a tap connection and then solder and tape it. Refer to appendix A for more detailed instructions on this type of connection if necessary. This wire may be lengthened or shortened if necessary.

**STEP 7.10 Brake Light Switch Wiring**  
**18 ga. Gray wire – main harness**

Locate the brake light switch output wire and connect the 18 ga. gray wire from the main controller harness. When the brake pedal is depressed this wire will have +12v on it, and ground when released. Strip back the insulation and perform a tap connection and then solder and tape it. Refer to appendix A for more detailed instructions on this type of connection if necessary. This wire may be lengthened or shortened if necessary.

**STEP 7.11 CNG Regulator Lock-off Solenoid and Temperature Sensor Wiring**  
**3 pin connector with 18 ga. Blue, Black and White wires – main harness**  
**2 pin connector with 18 ga. Orange and 18 ga. Black wires – main harness**

Position the CNG Fuel Level Interface near the regulator and plug the 4 pin connector from the regulator into the 4 pin connector from this unit. . The 4 pin connector from the CNG Fuel Level Interface will plug into the 4 pin plug from the main harness that has the 18ga. blue, black, and red/white wires. The 2 pin connector from the regulator that houses the pink/green and black wires is to be plugged into the mating 2 pin connector pigtail on the main harness that houses the pink and black wires.

**STEP 7.12 In-tank Solenoid Wiring for CNG tanks with an electric valve**  
**18 ga. Blue/black striped wire – main harness**

For CNG tanks that incorporate in-tank valves, the main controller harness contains a control wire. To connect this feature, extend the Blue/black wire from the main controller harness back to the CNG tank solenoid. Install a fuse holder and 5A fuse at the controller harness connection using a Western Union type connection (refer to appendix A for more detail). Connect this wire to one side of the solenoid (red wire if color coded) using a Western Union type connection (refer to appendix A for more detail) and install and solder a ring terminal on the other lead from the solenoid (black wire if color coded) and secure to a good ground.

## **STEP 7.14 Controller Ground**

### **14 ga. Black wire - main harness**

Route this wire directly to the negative battery post. Cut the 14 ga black wire to length and solder on a ring terminal for connection to the battery. For runs exceeding 10 Ft. upsize to a 10 ga black wire from the battery negative post to the controller and make the connection into the 14 ga black wire within 24" of the controller.

## **STEP 7.15 Key On Power Source**

### **18 ga. Red/white striped wire - main harness**

Route this wire to a source of 12 volts that is active when the ignition key is in the "on" and "crank" positions. On vehicles that have a secondary engine kill, such as dual steer sanitation trucks, power to this red/white lead must be interrupted when any of the engine kill switches activate. Strip back the insulation and perform a tap connection and then solder and tape it. Refer to appendix A for more detailed instructions on this type of connection if necessary. This wire may be lengthened or shortened if necessary.

## **STEP 7.16 Main Supply Power**

### **14 ga. Red wire – main harness**

Route this wire directly to the battery positive post. Install the supplied fuse holder onto this wire using a Western Union type connection (refer to appendix A for more detail) and install and solder a ring terminal on the other lead from the fuse holder. Before connection to the battery post, remove the fuse. Connect the ring terminal to the battery positive post, secure, then re-install the fuse. For runs exceeding 10 Ft. upsize to a 10 ga red wire from the battery positive post to the controller and make the connection into the 14 ga red wire within 24" of the controller.

## **STEP 7.17 USB Cable**

The base of the controller has a weatherproof USB connector for laptop connection. Remove the weather cap and connect any standard USB cable that is terminated with a USB-A and USB-B end. A 15 ft. weatherproof cable is available from Technocarb. This cable mounts to the USB connector and also provides a vibration proof connection for extended use. When replacing the weather cap be careful not to over tighten it.

NOTE: The laptop should run only on it's own battery power or on shore power during programming and system monitoring. Using an inverter in the vehicle to power the laptop may cause communication issues with the USB and subsequent controller lockup due to ground loop issues. Should lockup occur it will be necessary to disconnect the large harness connector for a few minutes to do a system reset.

# Wiring Schematic

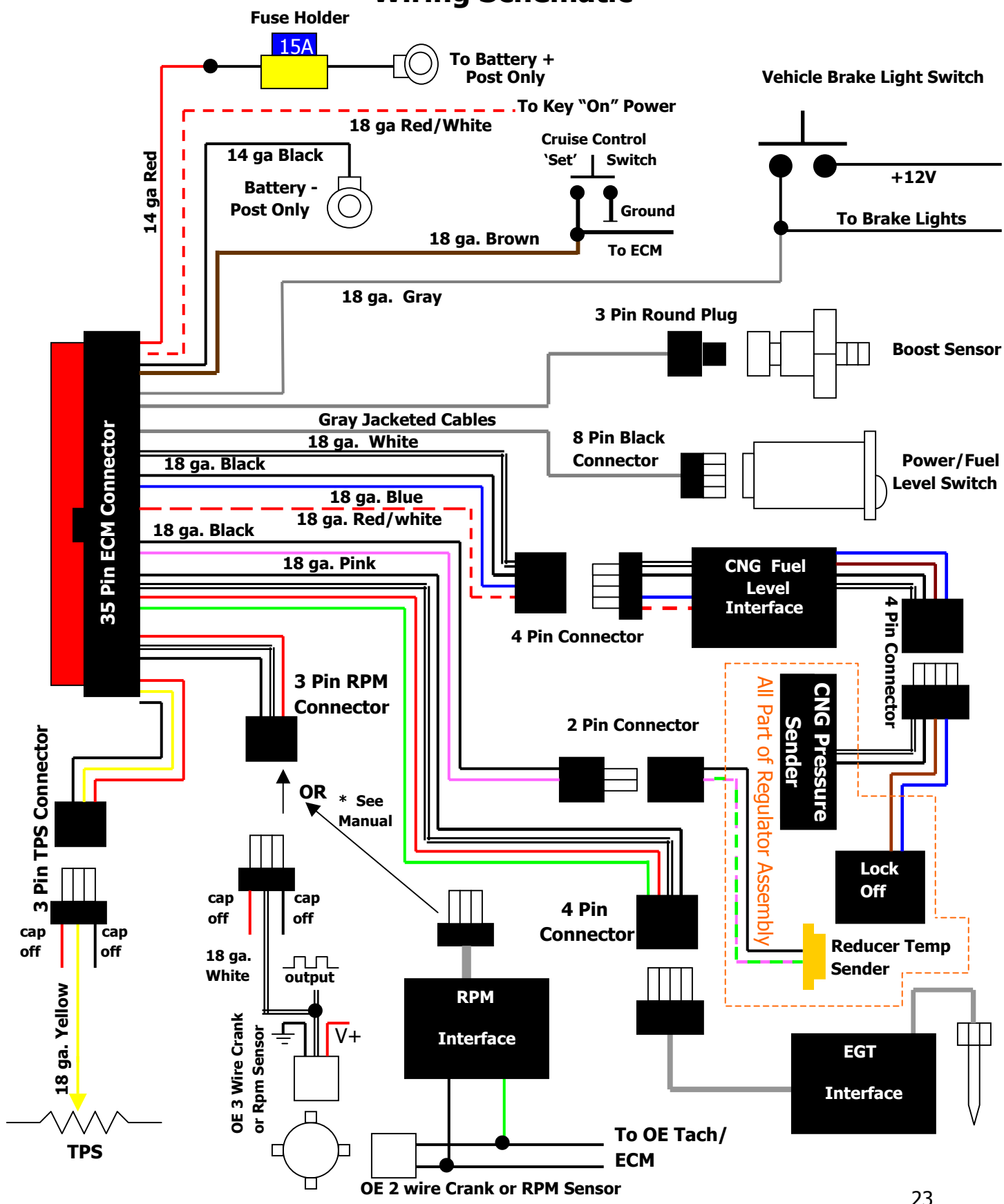

# Appendix A

## Wiring Techniques

### TAP CONNECTION

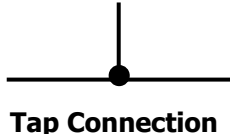

This type of connection is used when tapping into a wire without interrupting the main circuit. Below is a pictorial of the steps to properly make a tap connection.

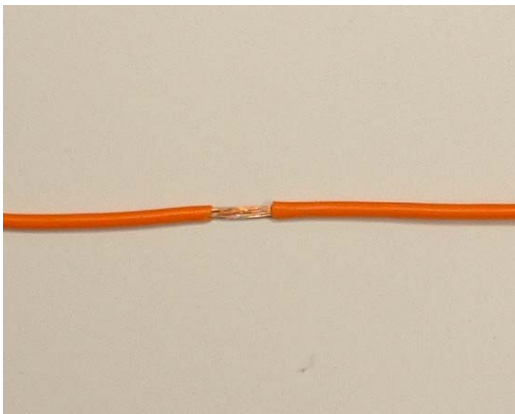

Strip a 1/2" – 3/4" section of the main wire

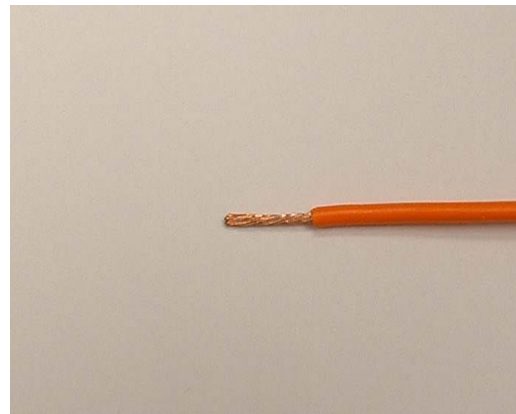

Strip back 1/2" – 3/4" from the end of the tap wire



Twist the tap wire into the main wire



Apply heat to the bottom of the connection and then apply solder slowly as it flows into the wire.



Once the solder has "wicked" into the joint remove the heat and let cool. Prior to taping the connection, check the finished solder joint for sharp edges or small wire protrusions that may poke through the tape later. If any are found simply take a small pair of pliers and gently flatten them. Tape the connection and secure the wiring.

## WESTERN UNION SPLICE CONNECTION

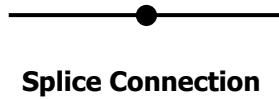

When making a splice connection, the best method is the Western Union connection. Below is a pictorial of the steps to properly make this type of connection.



Begin by stripping  $\frac{1}{2}$ " –  $\frac{3}{4}$ " of insulation off each end of wire. Slip  $\frac{1}{4}$ " piece of double wall heat shrink tubing on one of the wires. Place the heat shrink away from the joint for now, a few inches is desirable.



Tightly twist the two wire neatly together

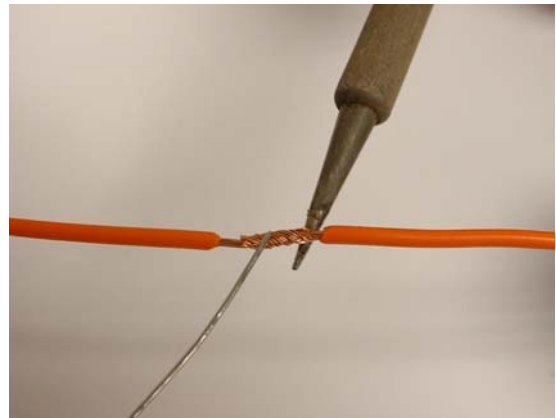

Apply heat to the bottom of the connection and then apply solder slowly as it flows into the wire.



Once the solder has "wicked" into the joint remove the heat and let cool. Prior to sealing the connection, check the finished solder joint for sharp edges or small wire protrusions that may poke through the heat shrink later. If any are found simply take a small pair of pliers and gently flatten them.



Center the heat shrink tubing over the soldered joint and then apply heat to shrink the tubing. A heat gun is best, however a small flame may be carefully used from a couple of inches away to slowly shrink the tubing.

# Ring Terminal Installation

Below is a pictorial of the steps to properly solder a ring terminal onto a wire. Soldering will ensure a connection does not become loose or corroded within the terminal barrel.

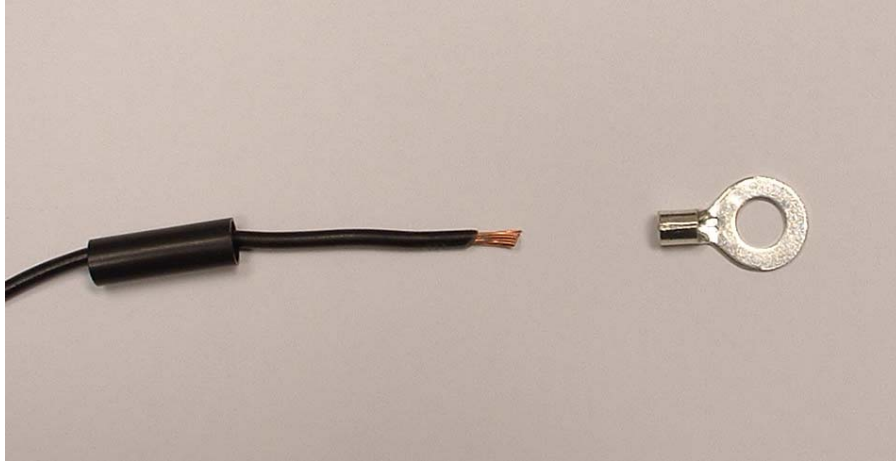

Begin by stripping 3/8" of insulation off one end of the wire. Slip a 1" piece of double wall heat shrink tubing over the wire. Place the heat shrink away from the joint for now, a few inches is desirable.

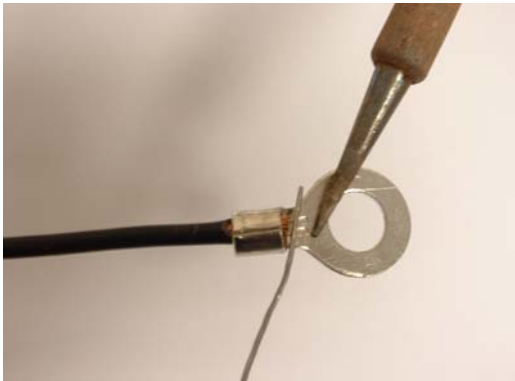

Apply heat to the terminal and apply solder against the wire, hold the heat until the solder begins to melt. Once the solder has flowed around the wire remove the solder and heat.



Once complete, the solder should be smooth and contour the terminal. If not, re-apply heat until the solder reflows. Allow the terminal to cool and then slide the heat shrink over the terminal barrel.



Apply heat to shrink the tubing, a heat gun is best, however a small flame may be carefully used from a couple of inches away to slowly shrink the tubing.

## Appendix B

### Air Compressor Charge Air Inlet Line Re-location

On some vehicles the air compressor will have it's inlet port routed to the intake manifold to utilize charge air. On applications such as these, this inlet line must be re-located upstream (turbo/intercooler side) of the gas injection nozzle to avoid gas being drawn into the air system.

In most cases this is easily done as the post turbo/intercooler route has sufficient space to remount the compressor inlet feed.

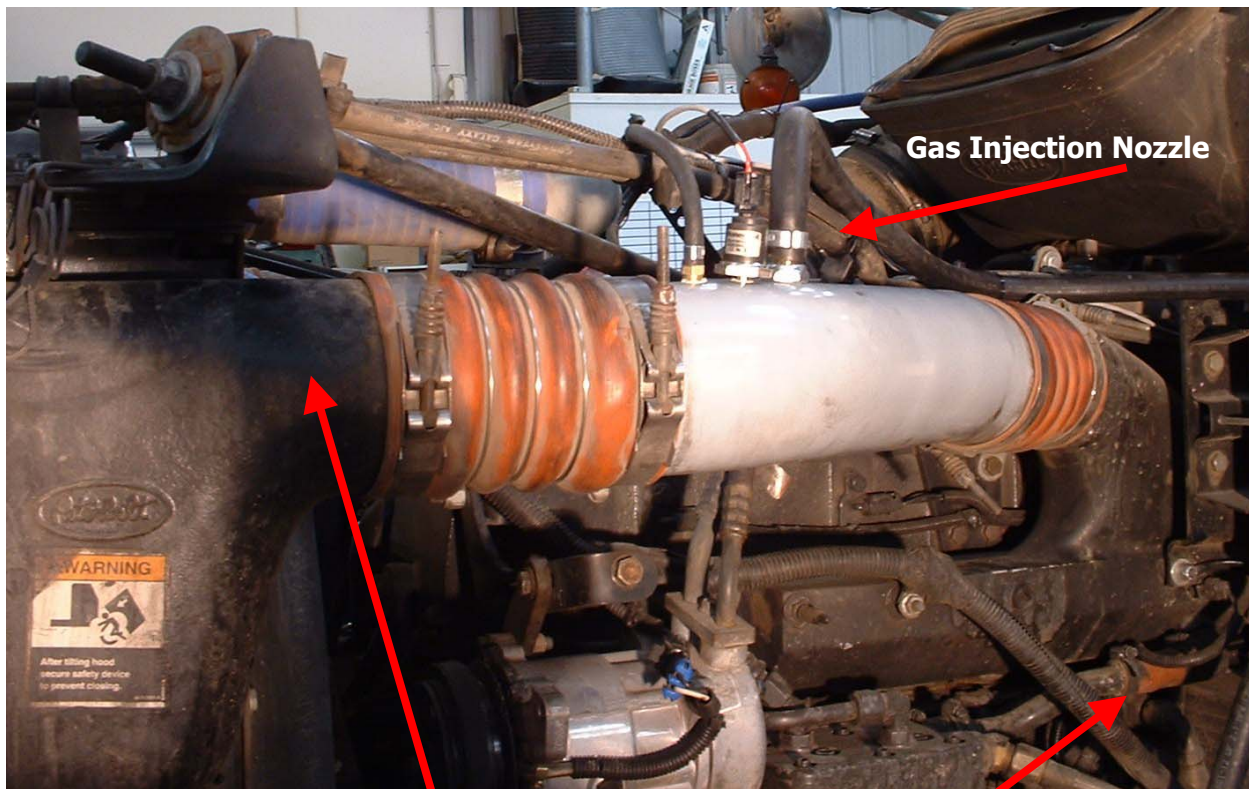

Suggested Relocation Point  
( reference only )

Original Charge Air Inlet Location

## **Appendix C**

### **Automatic Transmission Torque Monitoring**

**Some newer vehicles employ torque monitoring diagnostics on automatic transmission platforms. Engine power increases may set a DTC for the transmission if higher than factory power levels are detected. These monitored levels are normally adjustable by the dealer and can be increased electronically. It is common for the same series of transmission to be used in a number of different power level applications and the factory settings are based on the original engine specifications.**

**Since the EcoDiesel will not only improve economy of the engine but also increase available torque, some vehicles may experience a DTC code for higher than expected torque. In such cases simply contact the vehicle dealer to have the threshold set to the next higher level.**

# Appendix D



## Controller Mounting Template



## Appendix E

# EcoDiesel System Installation

## For 24 and 36 volt systems

The EcoDiesel Systems is designed for use with 12 volt negative ground systems. For vehicles that run on either 24 or 36 volt systems, a 12 volt source will need to be isolated. First check whether the vehicle already has a 12 volt subsystem already wired in, if so use this system. Otherwise wiring a 12 volt subsystem may be easily done as long as the battery bank is made up of 12 volt batteries. The process will simply require tapping a 12 volt feed from the battery wired closest to ground and the installation of a relay to provide a switched 12 volt source when the ignition is energized. The schematic below shows the necessary wiring for a 12 volt subsystem.

